

# LEGIBILITY NOTICE

A major purpose of the Technical Information Center is to provide the broadest dissemination possible of information contained in DOE's Research and Development Reports to business, industry, the academic community, and federal, state and local governments.

Although a small portion of this report is not reproducible, it is being made available to expedite the availability of information on the research discussed herein.

CONF-87-26

Los Alamos National Laboratory is operated by the University of California for the United States Department of Energy under contract W-7405-ENG-36

LA-UR--87-2079

DE87 011766

TITLE: EXPECTATIONS FOR THE LAGUNA FOIL IMPLOSION EXPERIMENTS

AUTHOR(S): A. E. Greene, X-10, J. H. Brownell, X-10  
R. S. Caird, M-6, J. H. Goforth, M-6,  
R. H. Price, P-1, and R. J. Trainor, P-1

SUBMITTED TO: Sixth IEEE Pulsed Power Conference, June 29-July 1, 1987,  
Marriott Crystal Gateway, 1700 Jefferson Davis Highway,  
Arlington, Virginia

DISCLAIMER

This report was prepared as an account of work sponsored by an agency of the United States Government. Neither the United States Government nor any agency thereof, nor any of their employees, makes any warranty, express or implied, or assumes any legal liability or responsibility for the accuracy, completeness, or usefulness of any information, apparatus, product, or process disclosed, or represents that its use would not infringe privately owned rights. Reference herein to any specific commercial product, process, or service by trade name, trademark, manufacturer, or otherwise does not necessarily constitute or imply its endorsement, recommendation, or favoring by the United States Government or any agency thereof. The views and opinions of authors expressed herein do not necessarily state or reflect those of the United States Government or any agency thereof.

By acceptance of this article, the publisher recognizes that the U.S. Government retains a nonexclusive, royalty-free license to publish or reproduce the published form of this contribution, or to allow others to do so, for U.S. Government purposes.

The Los Alamos National Laboratory requests that the publisher identify this article as work performed under the auspices of the U.S. Department of Energy.



Los Alamos Los Alamos National Laboratory  
Los Alamos, New Mexico 87545

JUL 1 1987

# EXPECTATIONS FOR THE LAGUNA FOIL IMPLOSION EXPERIMENTS\*

A. Greene, J. Brownell, R. Caird, J. Goforth, R. Price, J. Trainor

Los Alamos National Laboratory  
Los Alamos, New Mexico

## ABSTRACT

Building on the results achieved in the Pioneer shot series, the Los Alamos Trailmaster project is embarking on the Laguna foil implosion experiments. In this series a Mark-IX helical generator will be coupled to an explosively formed fuse opening switch, a surface-tracking closing switch, and a vacuum power flow and load chamber. In this paper the system design will be discussed and results from zero-, one-, and two-dimensional MHD simulations will be presented. We presently anticipate that the generator will provide more than 10 MA of which  $\sim 5.5$  MA will be switched to the 5-cm-radius, 2-cm-high, 250-nm-thick aluminum foil load. This should give rise to a 1  $\mu$ s implosion with more than 100 kJ of kinetic energy.

## Introduction

The Pioneer shot series in the Los Alamos Trailmaster project demonstrated the proof of principle of using a high-explosive, flux-compression generator to drive plasma implosions. That series of experiments provided an important testbed for solving numerous system and power conditioning problems, the development of diagnostics that could survive in a doubly hostile environment, and verification of computer modeling capabilities. Details of the Pioneer results are documented in the Digest of Technical Papers of the 5th IEEE Pulsed Power Conference. The Laguna shot series will be performed at significantly higher energies and will be prototypic of a megajoule system.

In this paper the system design that has been developed for the Laguna series, the criteria used to select components for the system, and the results of computer simulations of the system performance will be discussed. A companion paper by J. H. Goforth, et al.<sup>1</sup> will discuss the results to date of various subsystem component tests. In addition, the explosively formed fuse opening switch and the surface-tracking closing switch are subjects of separate papers to be presented at this conference.<sup>2,3</sup>

\*Work supported by the U.S. Department of Energy.

## The Laguna System

The Laguna system will consist of a Mark IX helical flux compression generator, an explosively formed fuse (EFF) opening switch, a surface-tracking closing switch, and a vacuum power flow and load chamber. In designing this system, demonstrated performance and reliability were our principal criteria for component selection. An equivalent electrical circuit for this system is shown in Fig. 1.

The capacitor bank in our system will be discussed in more detail in the companion paper. Basically, we are using the equivalent of a 1.5 mF bank with 120 nH of inductance and 3.3 m $\Omega$  of resistance which will be charged to 40 kV. This bank will impose a seed current of 450 kA in the initial 7.2  $\mu$ H inductance of the Mark IX generator in approximately 150  $\mu$ s.

The Mark IX helical generator was first demonstrated in 1983. It has consistently put currents of 10 to 11 MA into loads of the order of 140 nH, about the size of the Laguna load. Details of the recent shots with the Mark IX will be discussed in the companion paper. We have used the demonstrated performance of the Mark IX to develop the heuristic inductance history which is shown in Fig. 2. The final inductance in this figure is 10 nH which is a token amount. Though this curve will predict significantly higher currents than have been observed, the predicted current is brought back in agreement with experiment by the 2.4 m $\Omega$  resistor in Fig. 1. This resistor, then, represents all losses in the generator. Therefore, this simple model makes the assumption that all the magnetic flux that has not shown as current by the end of the generator run is lost and not available to our experiment.

The inductor labeled S.I. in Fig. 1 is the storage inductor. In the Laguna system we expect to run the generator to completion so that this inductor will be the store of energy that is available to drive the implosion. Some of this inductance is inevitable because it represents the cables and cable connection between the Mark IX generator and the explosively formed fuse. The remaining inductance is discretionary. Too much inductance and the generator will produce too little current, too little and the circuit will not transfer current efficiently to the load. We are presently planning to use a 90 nH inductor in the Laguna system.

It should be noted from Fig. 2 that the run time for the Mark IX generator is about 190  $\mu$ s. Therefore, the combined time of the capacitor bank and the generator is around 340  $\mu$ s. This is a very long time for a pulsed power system and essentially dictated our choice of an opening switch. There are really very few opening switch candidates that will accept 10 MA of current, conduct for 340  $\mu$ s and still open reliably.

We have been working on explosively formed fuses for many years and details of this specific switch will be presented in a separate talk at this conference.<sup>2</sup> The basic idea of this switch is that the channel to be interrupted is formed by a metal

sheet that is thick enough that it can carry the amount of current expected in the experiment without fusing. In this case we are using a 0.8-mm-thick sheet of aluminum. As Fig. 3 shows, on one side of the aluminum is high explosive, on the other is a series of dies made from an insulating material such as teflon. When the high explosive is detonated it drives the aluminum into the dies. This stretches and thins the metal to the point that it will fuse.

In our computer simulations of the Laguna system we are using the curve for resistance as a function of time for the EFF as shown in Fig. 4. This curve was extrapolated from experimental results on small scale systems. To date, the large system has, in fact, produced somewhat faster resistance increases. In this large system the aluminum sheet is 76 cm long and there are 100 circular die patterns. This length is dictated by the desired resistance increase and the need to dissipate as much as 5 MJ of energy as the switch opens. However, it is this length that is responsible for the 33 nH of inductance in this switch.

The time dependent resistance marked with the initials STS on Fig. 1 is the surface-tracking switch. Again, this switch is the subject of a separate talk at this conference so we will not go into detail in this paper.<sup>3</sup> Basically, this is a self-breaking isolation switch. The voltage at which the switch begins to conduct depends on the separation of the electrodes (that is, the distance that the tracks must run) and the thickness and type of insulation on which the tracks form. In the Laguna shots we are planning to use an electrode spacing of 15 cm; the insulation will be 100-mil-thick mylar.

Tests that have been performed at the Air Force Weapons Laboratory and at Los Alamos indicate that this switch will begin to conduct when the voltage across it is close to 100 kV. The model, which is discussed in reference 3, predicts the resistance curve shown in Fig. 5. We have made numerous runs with this computer model, varying the time behavior of this curve and the minimum resistance of the switch when it is conducting. We find that the overall system behavior does not depend sensitively on these parameters.

A diagram of the power flow channel for the Laguna system is shown in Fig. 6. The blank area at the bottom of the diagram, between the interface with the switch/generator and the cathode, will be filled with alternating layers of plywood and lead. The powerflow channel sits directly on top of the explosively formed fuse which has an axial detonation system. This "plylead" region protects the load from the shock wave of the high explosive long enough for the electrical pulse to reach the load and the implosion to occur.

There are several features of the vacuum powerflow channel that are noteworthy. The voltage between the cathode (the bottom electrode) and the anode will

be divided by means of a stack of four thin donut shaped aluminum rings that will be connected electrically by means of a  $\text{CuSO}_4$  moat.

Inside the vacuum interface the cathode, the aluminum rings, and the anode will all undergo a gentle convolution. The convolutes in the aluminum rings will serve as baffling to protect the Teflon of the interface from radiation. The anode will be a series of 36 vanes. These vanes will allow the radiation to escape to reach the diagnostics. Inside the vacuum the cathode surfaces will be anodized; the anode surfaces will be bare aluminum.

We calculate that the powerflow channel will have 9 nH of inductance between the EFF and the vacuum interface and 11 nH between the interface and the foil load. The load foil will be pure aluminum, 2 cm high by 5 cm in radius, 250 nm thick.

### System Expectations

The performance of the Laguna system has been simulated using a zero-dimensional slug model, a one-dimensional Lagrangian MHD code and a two-dimensional Eulerian MHD code. The 0-D and 1-D codes share a circuit modeling package that will model the circuit shown in Fig. 1. This model, with the inductance curve of Fig. 2, predicts that the Mark IX generator will produce nearly 12 MA if the storage inductor is 90 nH. It should be noted that this is somewhat more current than the Mark IX has ever produced, and this result is dependent on the inductance model.

Figure 7 shows that the code predicts that some 5.3 MA of current will pass through the foil/plasma load. This relatively inefficient current transfer stems from the fact that the resistance and, hence, the voltage generated by the opening switch does not come up fast enough to move most of the current to the load before the implosion occurs. Note that Fig. 1 shows a time dependent resistor at the position of the  $\text{CuSO}_4$  moat. In the calculation we allow this resistor to drop to zero when the voltage across it reaches 250 kV. We feel that this is a conservative estimate of the voltage that this powerflow channel can stand-off. This voltage is reached due to the rapid increase in the inductance of the load as it implodes. It is this simulated breakdown of the powerflow channel that causes the rapid drop of the current in Fig. 7.

Figure 7 also shows the 0-D prediction of the kinetic energy of the implosion. This calculation is arbitrarily cutoff at a 10:1 implosion ratio assuming that instabilities will dominate the implosion beyond this point. We are predicting, then, a 1.1  $\mu\text{s}$  implosion that will reach about 110 kJ of kinetic energy. It should be noted that the 0-D and 1-D codes predict essentially the same results at the 10:1 implosion point.

Temperatures predicted by the 1-D simulation are shown in Fig. 8. As mentioned, at some point instabilities will grow to the point that they will dominate

the implosion. Therefore, the temperatures and kinetic energies shown in Fig. 8 will certainly not be reached. Growth of magnetically-driven Rayleigh-Taylor instabilities have been studied with a 2-D Eulerian code. The results of these 2-D simulations indicate that the 5 cm  $\times$  250 nm load in the Laguna system will be quite unstable. If these results are borne out by experiment, a 4 cm  $\times$  500 nm foil will be used. The 2-D code indicates that this 4 cm load will be much more stable and the 0-D code predicts that it will provide essentially the same kinetic energy. (The question is which load will provide the higher radiation temperature.)

### References

1. J. H. Goforth, R. S. Caird, C. M. Fowler, A. E. Greene, H. W. Kruse, I. R. Lindemuth, H. Oona, and R. E. Reinovsky, "Performance of the LAGUNA Pulsed Power System," 6th IEEE Pulsed Power Conference, June 29-July 1, 1987, Marriott Crystal Gateway, 1700 Jefferson Davis Highway, Arlington, Virginia.
2. J. H. Goforth, R. S. Caird, A. E. Greene, I. R. Lindemuth, S. P. Marsh, and H. Oona, "Advances in Explosively Formed Fuse Opening Switches," 6th IEEE Pulsed Power Conference, June 29-July 1, 1987, Marriott Crystal Gateway, 1700 Jefferson Davis Highway, Arlington, Virginia.
3. P. E. Reinovsky, J. H. Goforth, A. E. Greene, and J. Graham, "Characterization of Surface Discharge Switches and High Power System Applications," 6th IEEE Pulsed Power Conference, June 29-July 1, 1987, Marriott Crystal Gateway, 1700 Jefferson Davis Highway, Arlington, Virginia.

## Figure Captions

- Fig. 1. Equivalent electrical circuit for the Laguna experiments.
- Fig. 2. Time history of the inductance of the Mark IX generator determined by matching experimental results.
- Fig. 3. Cut away diagram of an explosively formed fuse. The inner cylinder is high explosive. Next to the high explosive is a thin metal sheet which fuses when it is carrying high current and the HE forces it into the rings teflon teeth.
- Fig. 4. Time history of the resistance of the explosively formed fuse during its opening phase. These values were extrapolated from small scale experiments.
- Fig. 5. Time history of the resistance of the surface-tracking closing switch calculated using the model described in Ref. 3.
- Fig. 6. Diagram of the Laguna powerflow region.
- Fig. 7. Predictions of the time history of the current delivered to the load (solid line) and the kinetic energy of the implosion (dashed line). These calculations were done with the zero dimensional model.
- Fig. 8. Temperature of the imploding plasma calculated by a 1-D Eulerian MHD code.



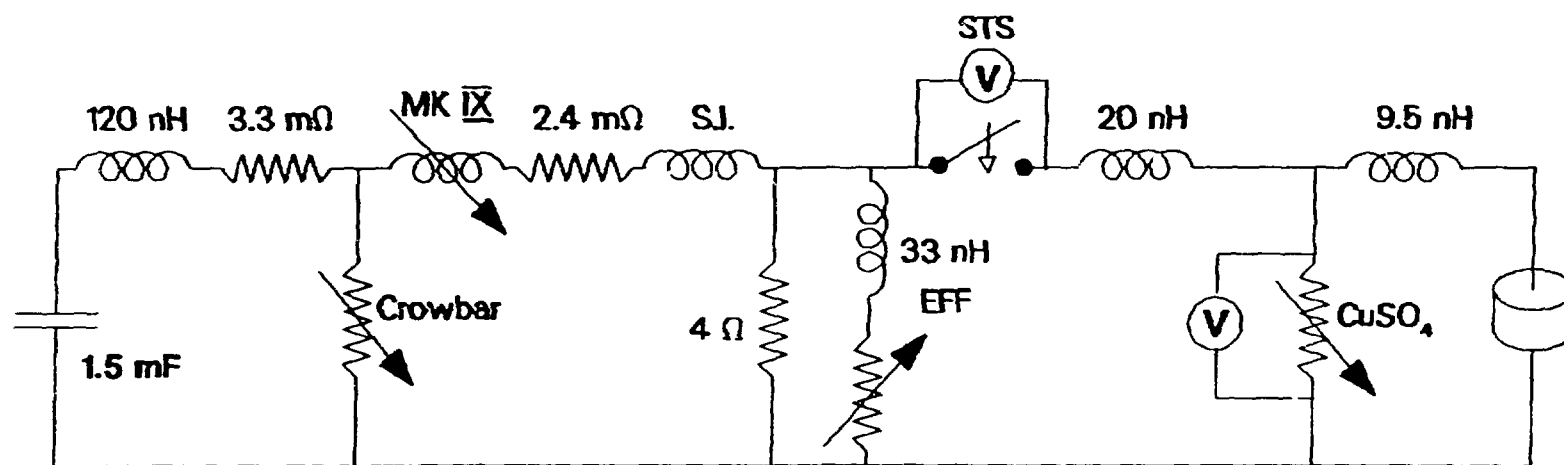

Laguna O-D conservative circuit

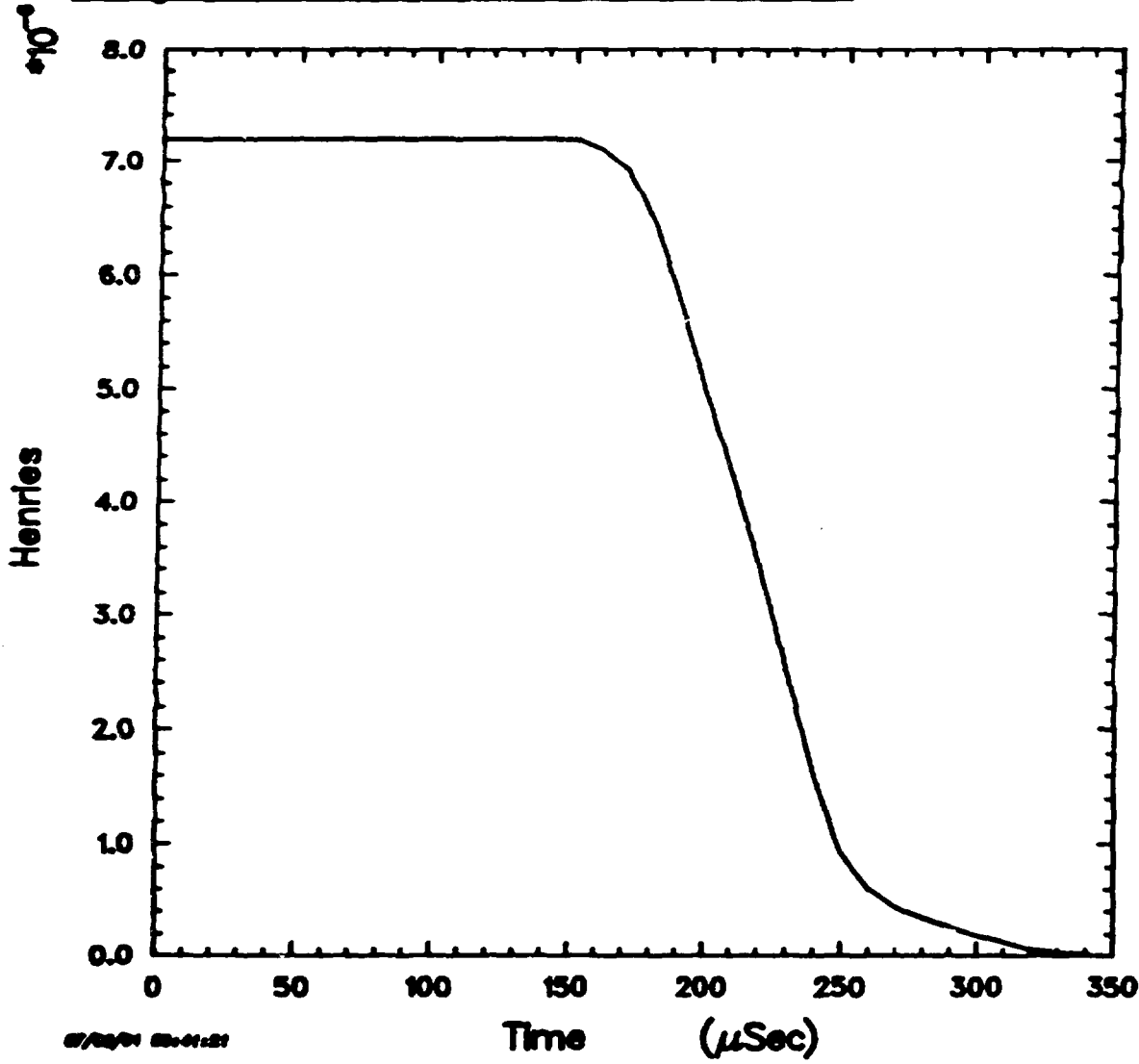

INDH(2)

07/03/91 09:41:21

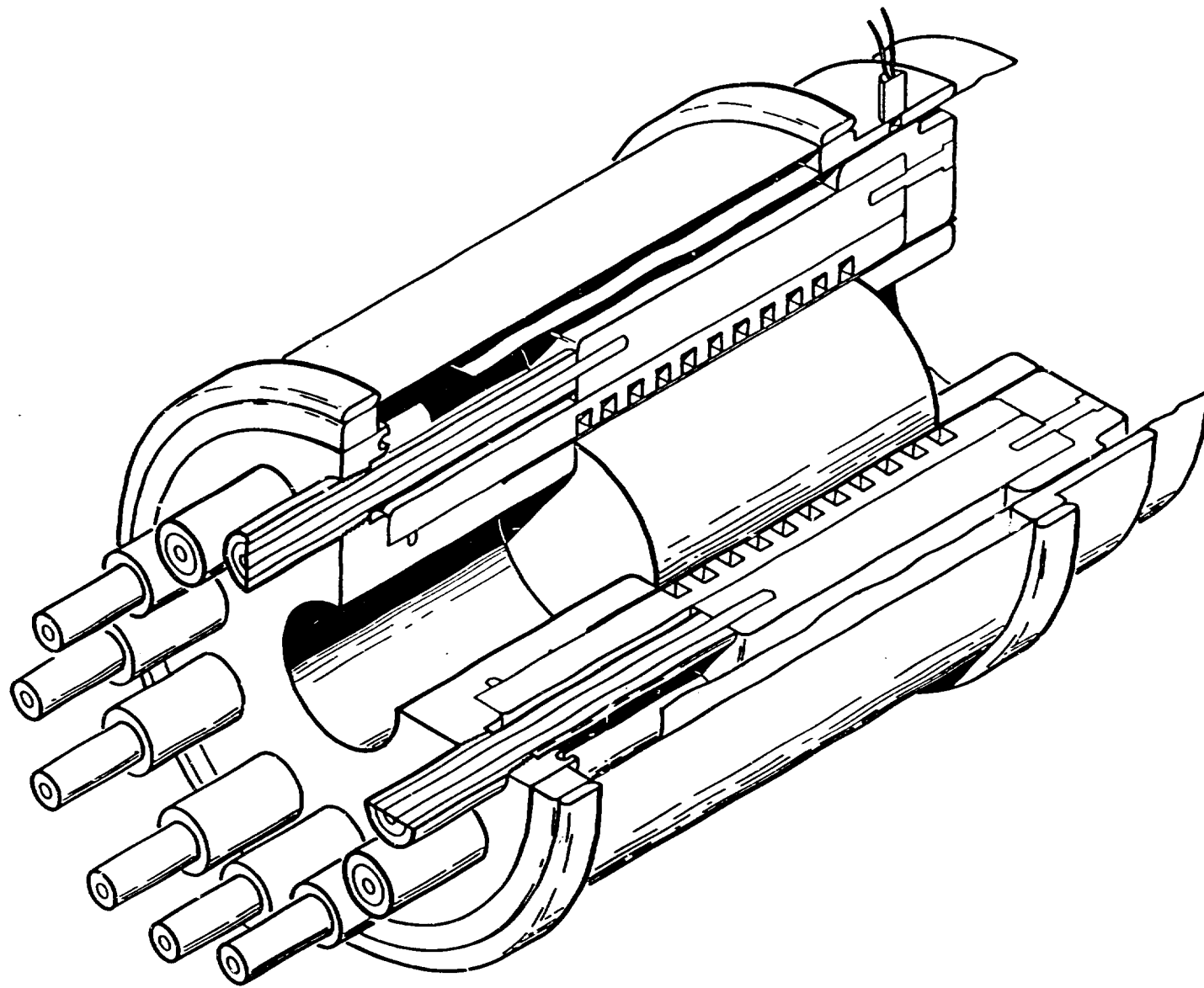

Laguna O-D conservative circuit

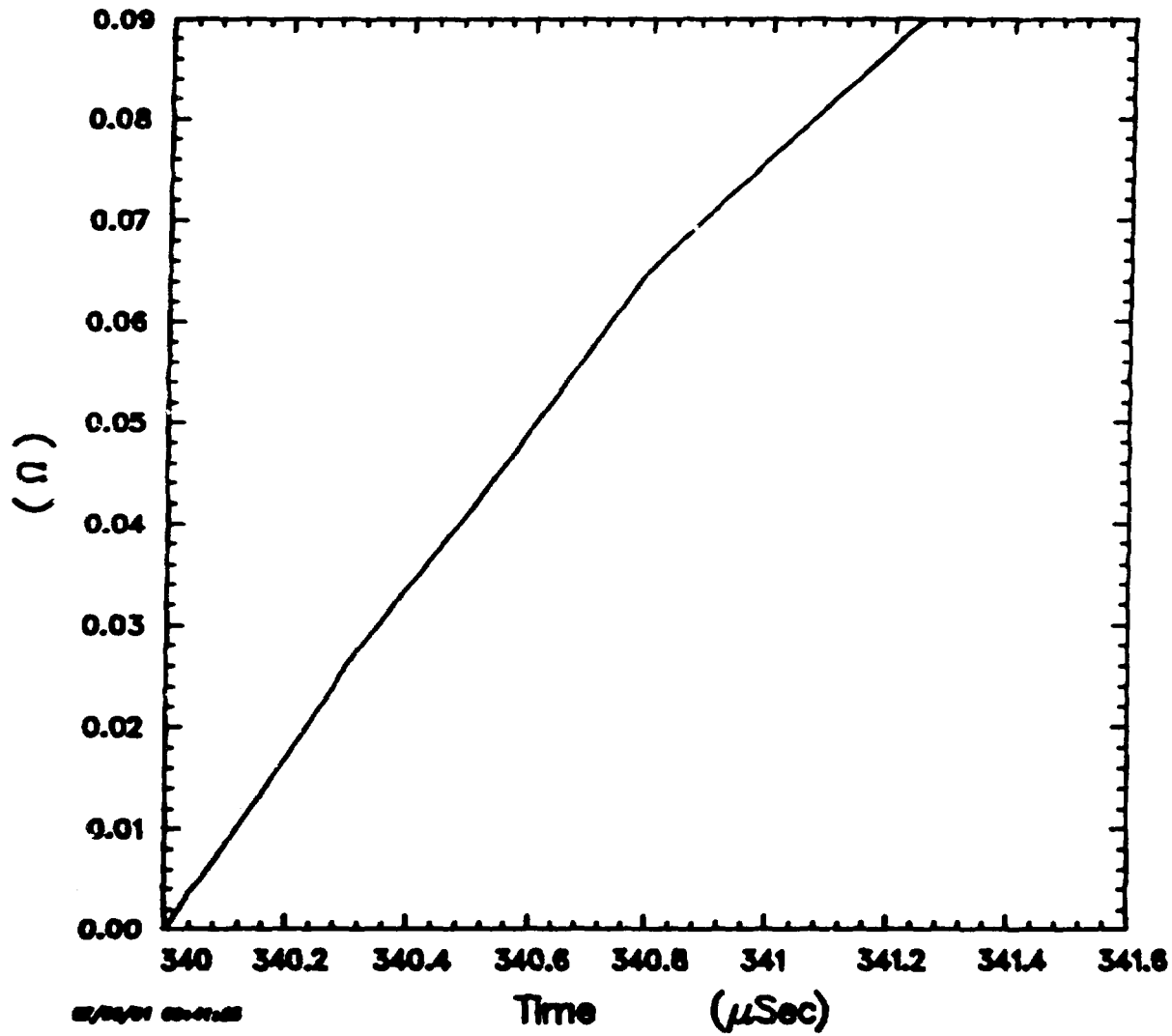

RESV(4)

02/04/01 09:41:05

Laguna O-D conservative circuit

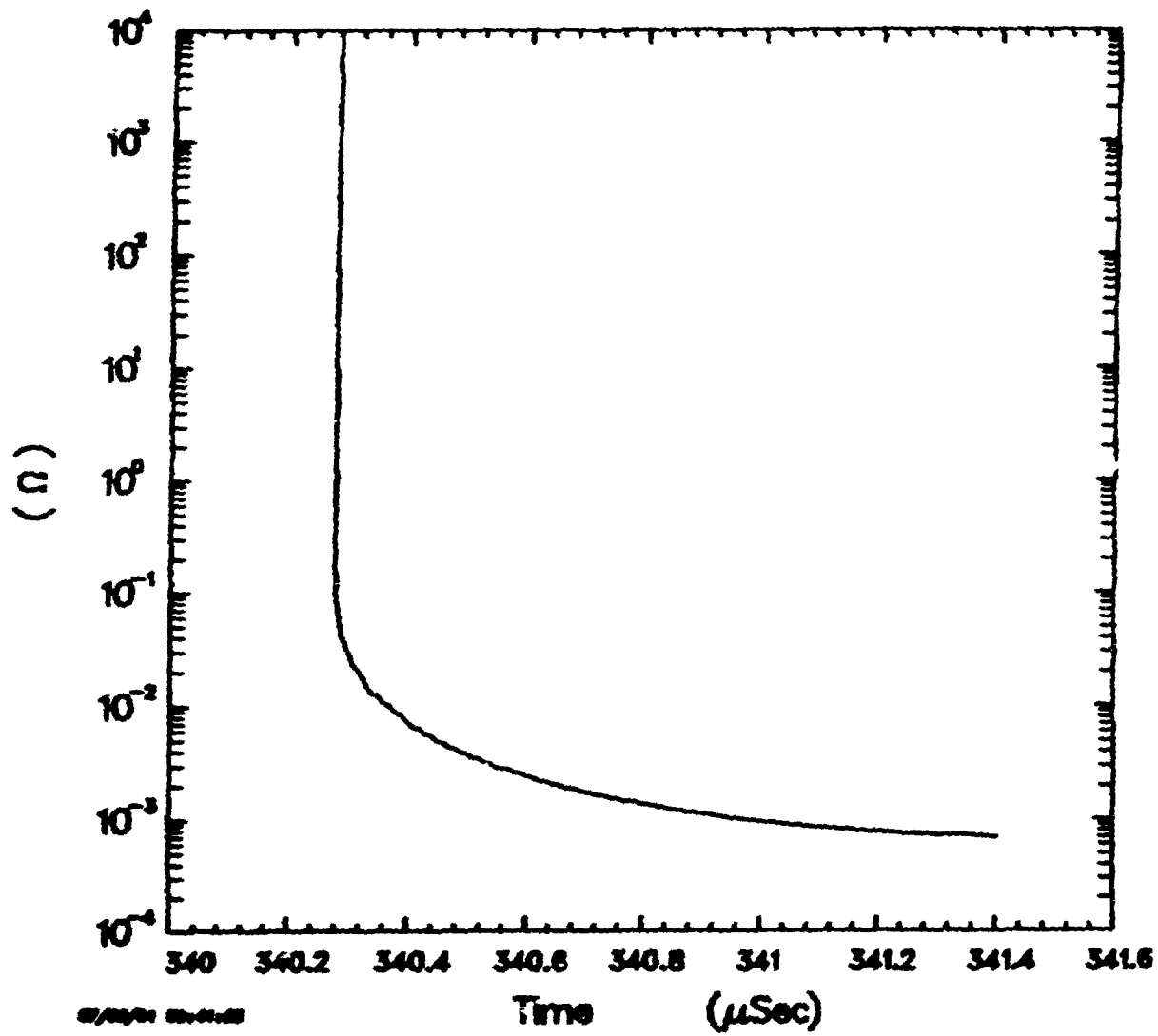

← RSTB(0)

# LAGUNA POWERFLOW CHANNEL

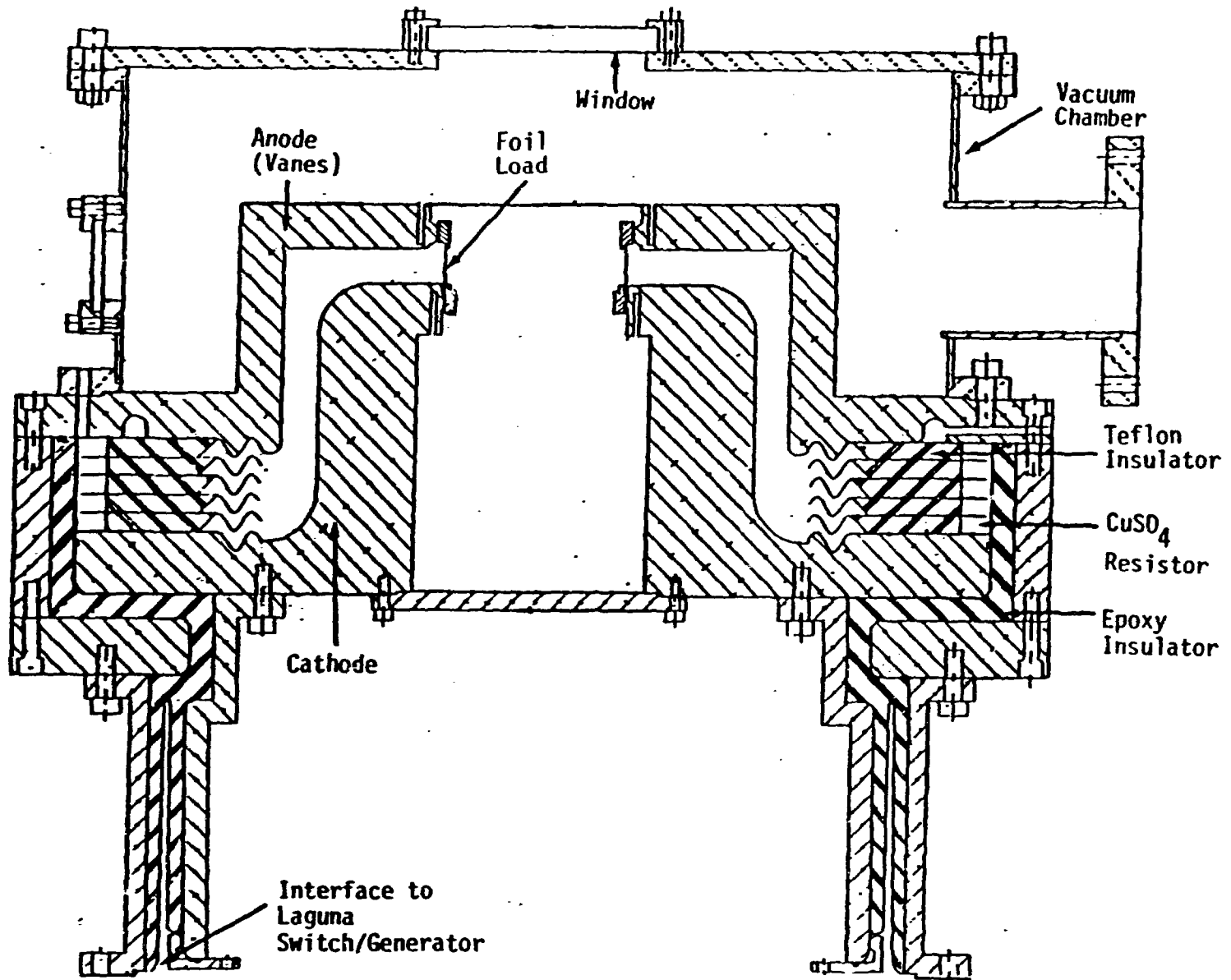

# Laguna O-D conservative circuit

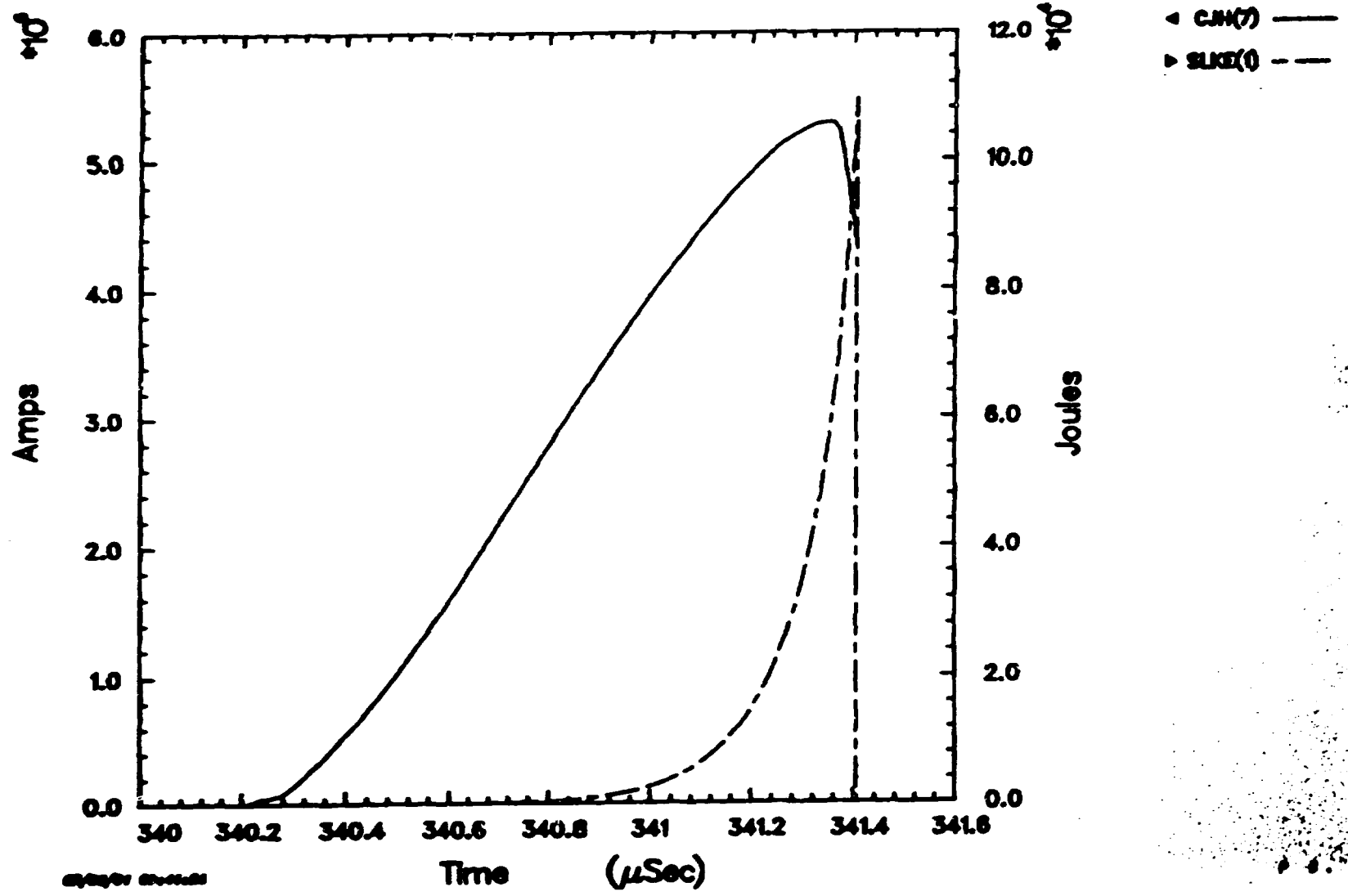

# Laguna 1-D sixth run

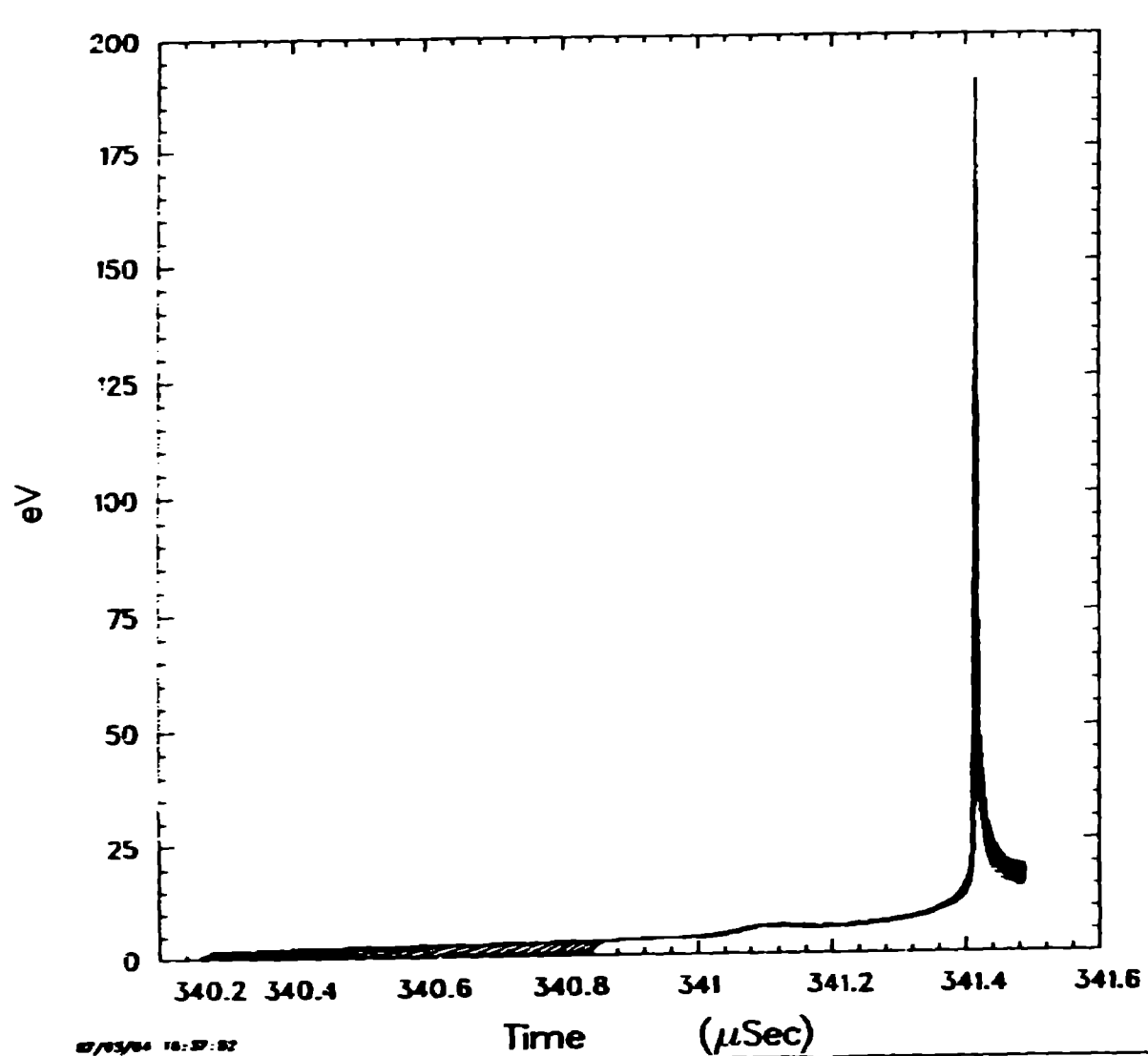

10/03/84 16:37:32